

Varenummer: 2309480181

Beskrivelse: E+G Flange vibrationsdæmper AVG-30

Mål

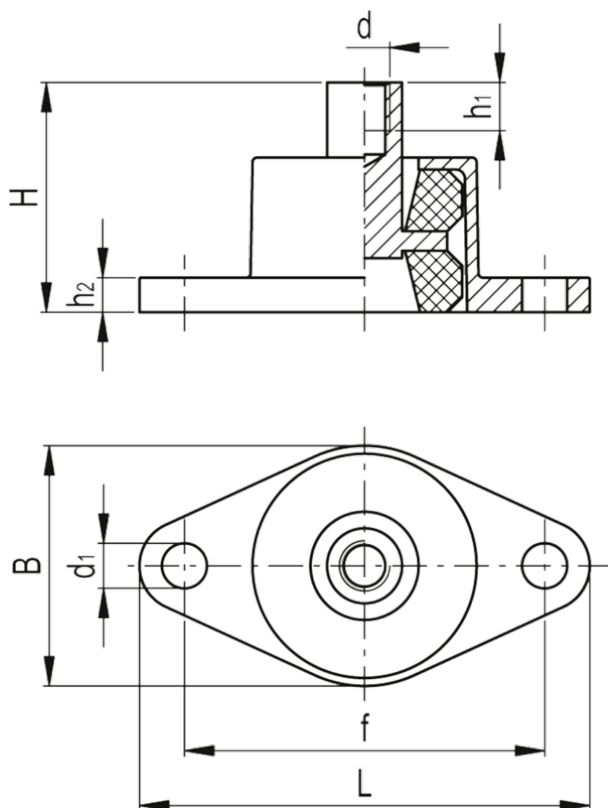

B = 80	Max. deflection = 6.5
d = M16	Max. load = 2700
d1 = 15	Min deflection = 3
f = 120	Min load = 700
H = 75	Shore A = 30
h1 = 16	Vægt i (g) = 650
h2 = 10	
L = 150	